

Switching ON/OFF

Ein-/Ausschalten
Mise en marche/arrêt



Lino L6R



2 sec = OFF

Power adjustment

Leistungseinstellung
Ajustement de puissance



Lino L6R



100-75-50%

Status LED

LED Status
Etat LED



Lino L6R

- Normal operation
Normaler Betrieb
Fonctionnement normal

- ☀ Instrument locked
Gerät gesperrt
Instrument bloqué

- Low battery
Tiefer Batteriestand
Batterie faible

- ☀ Out of level
Ausserhalb des
Selbstnivellierbereichs
Hors du niveau

Adapter Setup

Adapter-Einrichtung
Configuration de l'adaptateur



250°

+/- 10°

Fine adjustment
Feineinstellung
Réglage fin

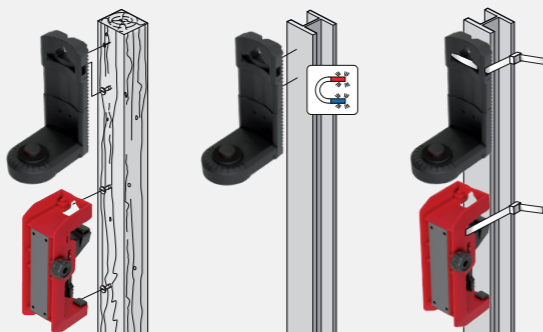

Usable with UAL 130

Verwendbar mit UAL 130
Utilisable avec UAL 130

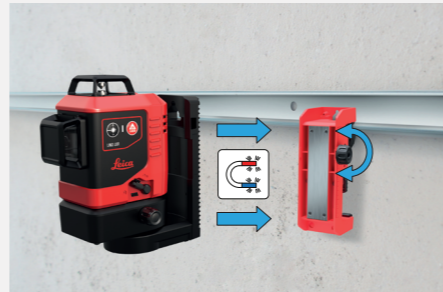

Usable with Receiver

Verwendbar mit Empfänger
Utilisable avec récepteur

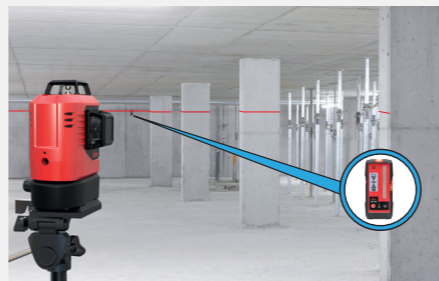

1 Window of horizontal line
Fenster horizontale Linie
Fenêtre de la ligne horizontale

2 Battery pack
Akkupack
Bloc-piles

3 Power adjustment
Leistungseinstellung
Ajustement de puissance

4 Laser key ON/OFF
Lasertaste EIN/AUS
Touche laser ON/OFF

5 Status LED
Status LED
LED d'état

6 Window of vertical line front
Fenster vertikale Linie vorne
Fenêtre de la ligne V frontale

7 Levelling lock
Nivellierungssperre
Blocage du nivellement

8 Fine adjustment knob
Feineinstellknopf
Bouton de réglage fin

9 Tripod thread 1/4"
Stativgewinde 1/4"
Filetage de trépied 1/4"

10 TWIST 250 adapter interface
TWIST 250 Adapterschnittstelle
Interface adaptateur TWIST 250

11 Window of vertical line side
Fenster vertikale Linie seitlich
Fenêtre de la ligne V latérale

Quick Start

Schnellstartanleitung

Guide de prise en main rapide

Leica Lino L6R



- when it has to be right

Leica
Geosystems

Insert batteries/Li-Ion
Batterien/Li-Ion einlegen
Insérer des piles/Li-Ion



1x - Laser on/
Vertical + horizontal mode

1x - Laser on/ vert. + horizont. Modus
1x - Laser on/mode vert. + horizont.

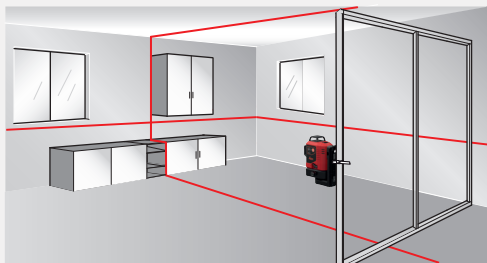

3x - Layout mode
3x - Absteck Modus
3x - Mode Implantation

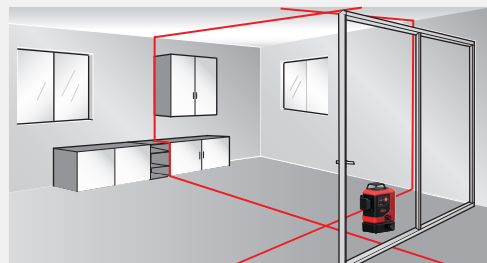

Horizontal mode
Horizontaler Modus
Mode horizontal



1x

Vertical mode
Vertikaler Modus
Mode vertical



2x

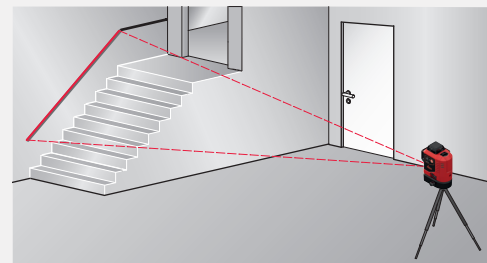

Transport



Charging Li-Ion battery
Li-Ion Batterie aufladen
Charger batterie Li-Ion



2x - All on mode
2x - All-on Modus
2x - Mode all on

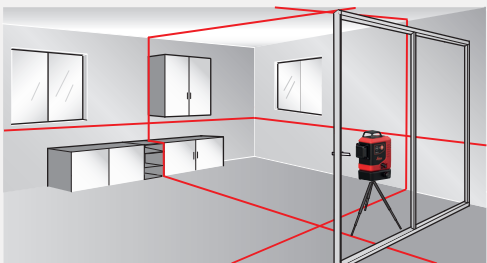

4x - Horizontal mode
4x - Horizontaler Modus
4x - Mode horizontal

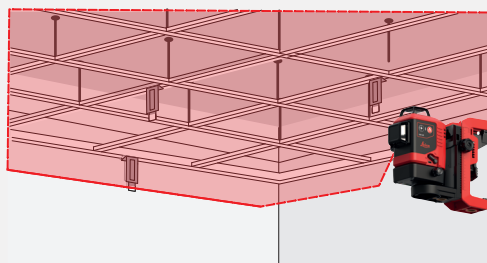

Self levelling/Levelling lock
Selbstnivellierung/Nivellierungssperre
Auto-nivellement/blocage du nivellement

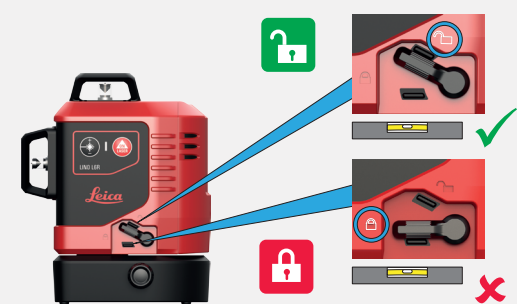

User Manual
Bedienungsanleitung
Manuel d'utilisation

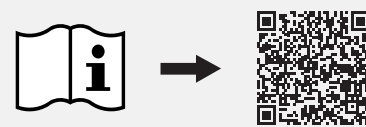

www.leica-geosystems.com

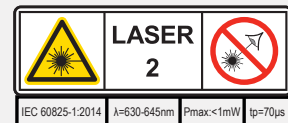

SAP. No. 913008